

eduard
MASK

SBD Dauntless 1/72

The die-cut mask for accurate canopy frame painting of the
Hasegawa
scale 1/72 KIT

CX 090

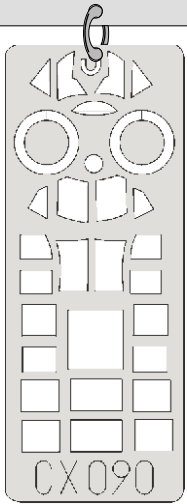

D8 (2x)

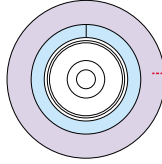

LIQUID MASK

N3

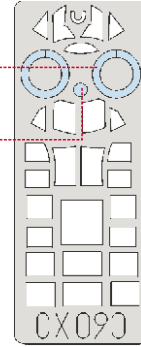

1.)

Q1

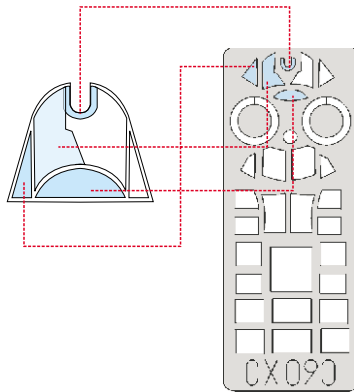

2.)

LIQUID MASK

Q1

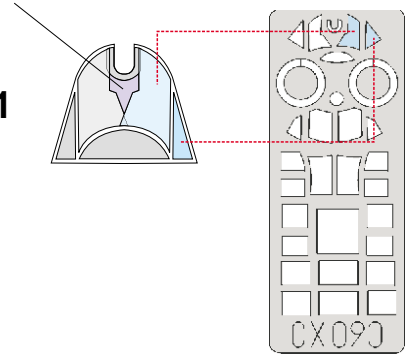

N1

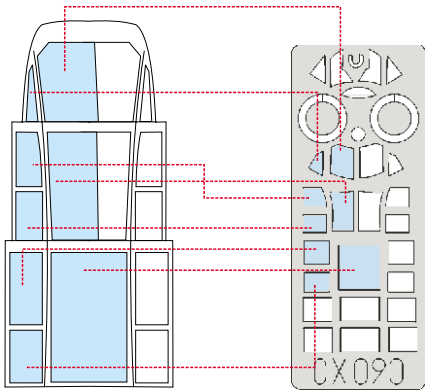

N1

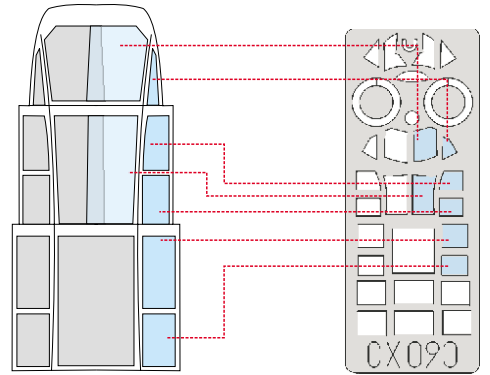

N2

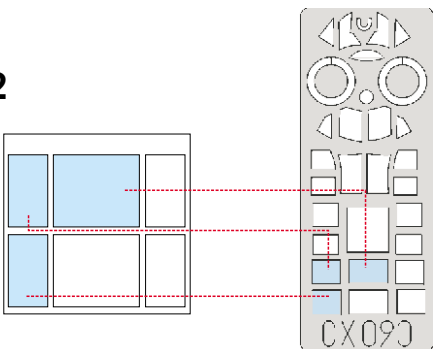

N2

